



Οδηγίες Χρήσης
User's Manual
Manuale d'installazione ed uso

ΚΛΙΜΑΤΙΣΤΙΚΟ ΤΟΙΧΟΥ DC INVERTER
WALL MOUNTED AIR CONDITIONER INVERTER TYPE
CONDIZIONATORE SPLIT

ΜΟΝΤΕΛΑ / MODELS / MODELLI
UTN/UTG-17AP
UTN/UTG-21AP

Ευχαριστούμε για την επιλογή σας στα κλιματιστικά οικιακής χρήσης TOYOTOMI.
Πριν χρησιμοποιήσετε αυτή τη συσκευή, παρακαλούμε διαβάστε προσεκτικά αυτό το εγχειρίδιο χρήσεως. Κρατήστε αυτό το εγχειρίδιο χρήσεως για μελλοντική αναφορά σε αυτό.

Thank you for your choice in TOYOTOMI Wall Mounted Air Conditioners.
Before using this product, be sure to read this Instruction Manual carefully to ensure proper usage. Keep this manual in good shape for future reference.

Grazie per aver scelto un prodotto TOYOTOMI.
Per un corretto funzionamento, leggere attentamente questo manuale prima di usare il condizionatore e conservarlo per una futura consultazione.

CONTENTS

THE REFRIGERANT 65-66

PRECAUTIONS..... 67-71

PARTS NAME 71-72

BUTTONS ON THE REMOTE CONTROLLER 73-74

INTRODUCTION FOR BUTTONS OF REMOTE CONTROLLER 75-83

REPLACEMENT OF BATERIES IN REMOTE CONTROLLER83

EMERGENCY OPERATION 83-84

CLEAN AND MAINTENANCE 84-86

TROUBLE – CAUSE – SOLUTION..... 86-88

INSTALLATION DIMENSION DIAGRAM 90-91

SAFETY PRECAUTION93

GROUNDING REQUIREMENT.....94

INSTALLATION OF INDOOR UNIT..... 94-100

INSTALLATION OF OUTDOOR UNIT..... 100-104

VACUUM PUMPING104

OPERATION TEST.....105

LEAKAGE DETECTION.....106

CONFIGURATION OF CONNECTION PIPE 106-107

SAFETY OPERATION OF FLAMMABLE REFRIGERANT108

INSTALLATION NOTES 108-109

MAINTENANCE NOTES.....109-110

CHECK AFTER INSTALLATION 110-112

SPECIALIST’S MANUAL..... 112-114

 **DANGER:** This symbol indicates a dangerous situation that if not avoided could lead to death or serious injury.

 **WARNING:** This symbol indicates a dangerous situation that if not avoided could lead to death or serious injury.

 **ATTENTION:** This symbol indicates a dangerous situation that if not avoided could lead to minor or moderate damage.

NOTICE: Indicates important information indicate the risk of material damage.

EXCEPTION CLAUSES

Manufacturer will bear no responsibilities when personal injury or property loss is caused by the following reasons.

Damage the product due to improper use or misuse of the product.

Alter, change, maintain or use the product with other equipment without abiding by the instruction manual of manufacturer.

After verification, the defect of product is directly caused by corrosive gas.

After verification, the defects are due to improper operation during transportation of product.

Operate, repair, maintain the unit without abiding by instruction manual or related regulations.

After verification, the problem or dispute is caused by the quality specification or performance of parts and components that produced by other manufacturers.

The damage is caused by natural calamities, bad using environment or force majeure.

THE REFRIGERANT



Appliance filled with flammable gas R32.



Before use the appliance, read the owner's manual first.



Before install the appliance, read the installation manual first.



Before repair the appliance, read the service manual first.

Refrigerant R32: GWP 675

- To realize the function of the air conditioner unit, a special refrigerant circulates in the system. The used refrigerant is the fluoride R32, which is specially cleaned. The refrigerant is flammable and inodorous. Furthermore, it can lead to explosion under certain conditions. But the flammability of the refrigerant is very low. It can be ignited only by fire.
- Compared to common refrigerants, R32 is a nonpolluting refrigerant with no harm to the ozonosphere. The influence upon the reenhouse effect is also lower. R32 has got very good thermodynamic features which lead to high energy efficiency. The units therefore need a less filling.

WARNING:

- DO NOT use means to accelerate the defrosting process or to clean, other than those recommended by the manufacture. Should repair be necessary, contact your nearest authorized Service Center. Any repairs carried out by unqualified personnel may be dangerous. The appliance shall be stored in a room without continuously operating ignition sources. (for example: open flames, an operating gas appliance or an operating electric heater.) DO NOT pierce or burn.
- Appliance shall be installed, operated and stored in a room with a floor area larger than 4m².
- Appliance filled with flammable gas R32. For repairs, strictly follow manufacturer's instructions only. Be aware that refrigerants not contain odor. Read specialist's manual.

1. Frequency band(s) in which the radio equipment operates:
2400MHz-2483.5MHz
2. Maximum radio-frequency power transmitted in the frequency band(s) in which the radio equipment operates: 20dBm

PRECAUTIONS



WARNING

Operation and Maintenance

- ❑ This appliance can be used by children aged from 8 years and above and persons with reduced physical, sensory or mental capabilities or lack of experience and knowledge if they have been given supervision or instruction concerning use of the appliance in a safe way and understand the hazards involved.
- ❑ Children shall not play with the appliance.
- ❑ Cleaning and user maintenance shall not be made by children without supervision.
- ❑ DO NOT connect air conditioner to multi-purpose socket. Otherwise, it may cause fire hazard.
- ❑ Always disconnect power supply when cleaning air conditioner. Otherwise, it may cause electric shock.
- ❑ If the supply cord is damaged, it must be replaced by the manufacturer, its service agent or similarly qualified persons to avoid a hazard.
- ❑ DO NOT wash the air conditioner with water to avoid electric shock.
- ❑ DO NOT spray water on indoor unit. It may cause electric shock or malfunction.
- ❑ After removing the filter, do not touch fins to avoid injury.
- ❑ DO NOT use fire or hair dryer to dry the filter to avoid deformation or fire hazard.
- ❑ Cleaning or maintenance MUST NOT be made by children. Supervision must always be provided by an adult responsible for their safety.
- ❑ Maintenance must be performed by qualified professionals. Otherwise, it may cause personal injury or damage. In such case warranty will be invalid.
- ❑ DO NOT repair air conditioner by yourself. It may cause electric

shock or damage. Please contact your dealer when you need to repair air conditioner.

- ❑ DO NOT insert fingers or objects into air inlet or air outlet. It may cause personal injury or damage.
- ❑ DO NOT block air outlet or air inlet. It may cause malfunction.
- ❑ DO NOT spill water on the remote controller, otherwise the remote controller may be broken.
- ❑ When below phenomenon occurs, please turn off air conditioner and disconnect power immediately and then contact the dealer or qualified professionals for service.
 - Power cord is overheating or damaged.
 - There is abnormal sound during operation.
 - Circuit break trips off frequently.
 - Air conditioner gives off burning smell.
 - There is a leakage from the indoor unit.
- ❑ If the air conditioner operates under abnormal conditions, it may cause malfunction electric shock or fire hazard.
- ❑ When turning on or turning off the unit by emergency operation switch, please press this switch with an insulating object other than metal.
- ❑ DO NOT step on top panel of outdoor unit, or put heavy objects. It may cause damage or personal injury.
- ❑ Installation must be performed by qualified professionals. Otherwise, it may cause personal injury or damage.
- ❑ Must follow the electric safety regulations when installing the unit.
- ❑ According to the local safety regulations, use qualified power supply circuit and circuit break.
- ❑ Install the circuit break. If not, it may cause malfunction.
- ❑ An all-pole disconnection switch having a contact separation of at least 3 mm in all poles should be connected in fixed wiring.
- ❑ Including an circuit break with suitable capacity, please note the following table. Air switch should be included magnet buckle

and heating buckle function, it can protect the circuit-short and overload.

- ❑ Air Conditioner should be properly grounded. Incorrect grounding may cause electric shock.
- ❑ DO NOT use unqualified power cord.
- ❑ Make sure the power supply matches with the requirement of air conditioner. Unstable power supply or incorrect wiring may result in electric shock, fire hazard or malfunction. Please install proper power supply cables before using the air conditioner.
- ❑ Properly connect the live wire, neutral wire and grounding wire of power socket.
- ❑ Be sure to cut off the power supply before proceeding any work related to electricity and safety.
- ❑ DO NOT put through the power before finishing installation.
- ❑ If the supply cord is damaged, it must be replaced by the manufacturer, its service agent or similarly qualified persons to avoid a hazard.
- ❑ The temperature of refrigerant circuit will be high, please keep the interconnection cable away from the copper tube.
- ❑ The appliance shall be installed in accordance with national wiring regulations.
- ❑ Installation must be performed in accordance with the requirement of NEC and CEC by authorized personnel only.
- ❑ The air conditioner is the first class electric appliance. It must be properly grounding with specialized grounding device by a professional. Please make sure it is always grounded effectively, otherwise it may cause electric shock.
- ❑ The yellow-green wire in air conditioner is grounding wire, which cannot be used for other purposes.
- ❑ The grounding resistance should comply with national electric safety regulations.
- ❑ The appliance must be positioned so that the plug is accessible.
- ❑ All wires of indoor unit and outdoor unit should be connected by

a professional.

- ❑ If the length of power connection wire is insufficient please contact the supplier for a new one. Avoid extending the wire by yourself.
- ❑ For the air conditioner with plug the plug should be reachable after finishing installation.
- ❑ For the air conditioner without plug, an circuit break must be installed in the line.
- ❑ If you need to relocate the air conditioner to another place, only the qualified person can perform the work. Otherwise, it may cause personal injury or damage.
- ❑ Select a location which is out of reach for children and far away from animals or plants. If it is unavoidable, please add the fence for safety purpose.
- ❑ The indoor unit should be installed close to the wall.
- ❑ Instructions for installation and use of this product are provided by the manufacturer.
- ❑ The air conditioner is not allowed to use in a room that has running fire (such as fire source, working coal gas ware, operating heater).
- ❑ It is not allowed to drill hole or burn the connection pipe. These tasks shall only be done by a licensed technician to ensure your safety.
- ❑ The air conditioner must be installed in a room that is larger than the minimum room area. The minimum room area is shown on the nameplate or following table a (page 108).
- ❑ Leak test is a must after installation.

Working temperature range

	Indoor Side DB/WB (°C)	Outdoor Side DB/WB (°C)
Maximum Cooling	32/23	43/26
Maximum Heating	27/-	24/18

NOTICE:

The operating temperature range (outdoor temperature) for heat pump unit is -15 °C ~ 43 °C.

PARTS NAME

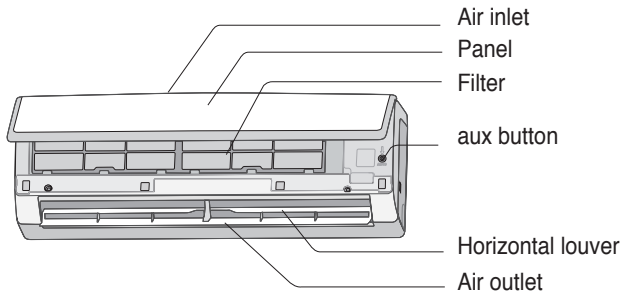

DISPLAY

Temp. indicator	26
Power indicator	⏻

Notice:

Actual product may be different from above graphics. Please refer to actual product.



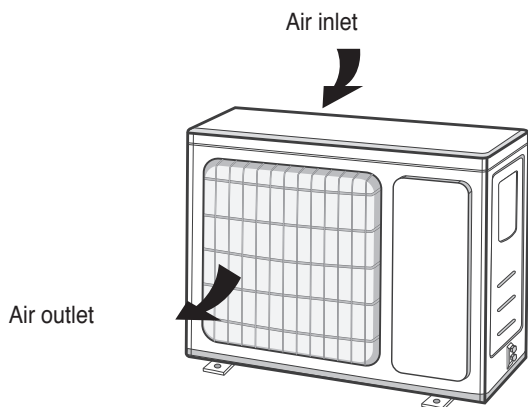



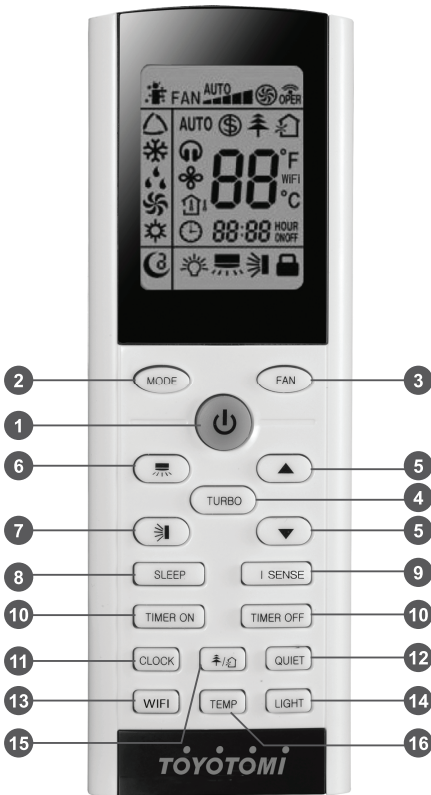















OUTDOOR UNIT



BUTTONS ON THE REMOTE CONTROLLER



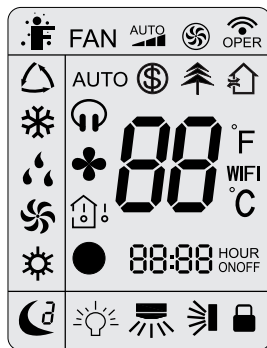

- 1 ON/OFF button
- 2 MODE button
- 3 FAN button
- 4 TURBO button
- 5 ▲/▼ buttons
- 6 button
- 7 button
- 8 SLEEP button
- 9 I SENSE button
- 10 TIMER ON / TIMER OFF buttons
- 11 CLOCK button
- 12 QUIET button (not available)
- 13 WIFI button
- 14 LIGHT button
- 15 / button
- 16 TEMP button

-  I SENSE
- FAN Fan Function
-  Set fan speed
-  TURBO Function
-  Send signal
-  AUTO mode
-  COOL mode
-  FAN mode
-  HEAT mode
-  Sleep Function
-  LIGHT Function
-  Left and right swing
-  Up and down swing
-  Lock
-  Clock
-  Temperature display type
-  Self-Clean Function
-  Quiet Function (not available)
- AUTO Auto Function
-  8°C Function
-  Ionizer
-  Scavenging – Fresh Air (not available)
-  Temperature in Fahrenheit
- WiFi WiFi Function
-  Temperature in Celsius
-  Set Time





Temperature display type

-  Set temperature
-  Indoor ambient temperature
-  Outdoor ambient temperature (not available)

INTRODUCTION FOR ICONS ON DISPLAY SCREEN

Note:

- ❑ This is a general use remote controller, it could be used for the air conditioners with multifunction; For some function, which the model does not have, if press the corresponding button on the remote controller that the unit will keep the original running status.
- ❑ After putting through the power, the air conditioner will give out a sound. Operation indicator  is ON. After that, you can operate the air conditioner by using remote controller.
- ❑ Under on status, pressing the button on the remote controller, the signal icon  on the display of remote controller will blink once and the air conditioner will give out a “de” sound, which means the signal has been sent to the air conditioner.







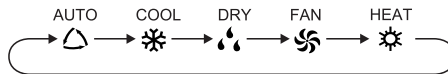

1 ON/OFF button

Press this button to turn on the unit. Press this button again to turn off the unit.





2 MODE button

Press this button to select your required operation mode.



- When selecting auto mode, air conditioner will operate automatically according to the sensed temperature. Set temperature cannot be adjusted and will not be displayed as well. Press «FAN» button can adjust fan speed. Press  /  button can adjust fan blowing angle.
- After selecting cool mode, air conditioner will operate under cool mode. Cool indicator  on indoor unit is ON (This indicator is not available for some models). Press ▲ or ▼ button to adjust set temperature. Press «FAN» button to adjust fan speed. Press  /  button to adjust fan blowing angle.
- When selecting dry mode, the air conditioner operates at low speed under dry mode. Dry indicator  on indoor unit is ON (This indicator is not available for some models). Under dry mode, fan speed cannot be adjusted. Press  /  button to adjust fan blowing angle.
- When selecting fan mode, the air conditioner will only blow fan, no cooling and no heating. All indicators are OFF, Operation indicator is ON. Press



«FAN» button to adjust fan speed. Press  /  button to adjust fan blowing angle.

- When selecting heating mode, the air conditioner operates under heat mode. Heat indicator  on indoor unit is ON (This indicator is not available for some models). Press  or  button to adjust set temperature. Press «FAN» button to adjust fan speed. Press  /  button to adjust fan blowing angle. (Cooling only unit will not receive heating mode signal. If setting heat mode with remote controller, press ON/OFF button cannot start up the unit).

Note:

- For preventing cold air, after starting up heating mode, indoor unit will delay 1~5 minutes to blow air (actual delay time is depend on indoor ambient temperature).
- Set temperature range from remote controller: 16~30°C (61~86°F); Fan speed: auto, low speed, low-medium speed, medium speed, medium-high speed, high speed.

3 FAN button

Pressing this button can set fan speed circularly as: auto (AUTO), ,  medium,  high.

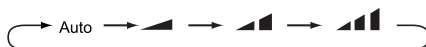



Note:

- Under AUTO speed, air conditioner will select proper fan speed automatically according to ex-factory setting.
- It is Low fan speed under Dry mode.
- X-FAN function Hold fan speed button for 2 seconds in COOL or DRY mode, the icon  is displayed and the indoor fan will continue operation for a few minutes in order to dry the indoor unit even though you have turned off the unit. After energization, X-FAN OFF is defaulted. X-FAN is not available in AUTO, FAN or HEAT mode.

This function indicates that moisture on evaporator of indoor unit will be blown after the unit is stopped to avoid mould.

4 TURBO button

Under COOL or HEAT mode, press this button to turn to quick COOL or quick HEAT mode.  icon is displayed on remote controller. Press this button again to exit turbo function and  icon will disappear. If start this function, the unit will run at super-high fan speed to cool or heat quickly so that the ambient

temp. approaches the preset temp. as soon as possible.

5 ▲/▼ button

- Press ▲ or ▼ button once increase or decrease set temperature 1°C (°F). Holding ▲ or ▼ button, 2 seconds later, set temperature on remote controller will change quickly. On releasing button after setting is finished, temperature indicator on indoor unit will change accordingly. (The temperature cannot be adjusted in AUTO mode.)
- When setting TIMER ON, TIMER OFF or CLOCK, press ▲ or ▼ button to adjust time. (Refer to CLOCK, TIMER ON, TIMER OFF buttons.) When setting TIMER ON, TIMER OFF or CLOCK, press ▲ or ▼ button to adjust time. (Refer to CLOCK, TIMER ON, TIMER OFF buttons.)

6 扇 button

Press this button can select left and right swing angle. Fan blow angle can be selected circularly as below:

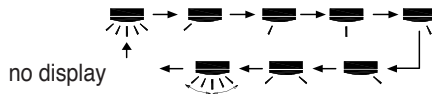

Note:

- Press this button continuously more than 2 seconds, the main unit will swing back and forth from left to right, and then loosen the button, the unit will stop swinging and present position of guide louver will be kept immediately.
- Under swing left and right mode, when the status is switched from off to 扇, if press this button again 2 seconds later 扇 status will switch to off status directly; if press this button again within 2 seconds, the change of swing status will also depend on the circulation sequence stated above.



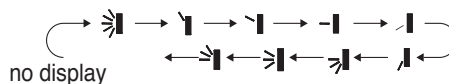

7 扇 button

- Press this button can select up and down swing angle. Fan blow angle can be selected circularly as below:







- When selecting 扇, air conditioner is blowing fan automatically. Horizontal louver will automatically swing up and down at maximum angle.
- When selecting 扇, air conditioner is blowing fan at fixed



position. Horizontal louver will stop at the fixed position.

- When selecting    air conditioner is blowing fan at fixed angle. Horizontal louver will send air at the fixed angle.
- Hold  button above 2 seconds to set your required swing angle. When reaching your required angle, release the button.



Note:

-    may not be available. When air conditioner receives this signal, the air conditioner will blow fan automatically.
- Press this button continuously more than 2 seconds, the main unit will swing back and forth from up to down, and then loosen the button. The unit will stop swinging and present position of guide louver will be kept immediately.
- Under swing up and down mode, when the status is switched from off to , if press this button again 2 seconds later,  status will switch to off status directly. If press this button again within 2 seconds, the change of swing status will also depend on the circulation sequence stated above.

8 SLEEP button

Under COOL or HEAT mode, press this button to start up sleep function.  icon is displayed on remote controller. Press this button again to cancel sleep function and  icon will disappear. After powered on, Sleep Off is defaulted. After the unit is turned off, Sleep function is canceled. Under FAN, DRY and AUTO modes, this function is not available.

9 I SENSE button







Press this button to start I SENSE function and  will be displayed on the remote controller. After this function is set, the remote controller will send the detected ambient temperature according to the controller and the unit will automatically adjust the indoor temperature according to the detected temperature. Press this button again to cancel I SENSE function and  will disappear.

USEFUL TIP









Please put the remote controller near user when this function is set. Do not put the remote controller near the object of high temperature or low temperature in order to avoid detecting inaccurate ambient temperature. When I SENSE function is turned on, the remote controller should be put within the area where indoor unit can receive the signal sent by the remote controller.

10 TIMER ON / TIMER OFF button

TIMER ON button

“TIMER ON” button can set the time for timer on. After pressing this button, icon disappears and the word “ON” on remote controller blinks. Press  button to adjust TIMER ON setting. After each pressing  or  button, TIMER ON setting will increase or decrease 1 minute. Hold  or  button, 2 seconds later, the time will change quickly until reaching your required time. Press “TIMER ON” to confirm it. The word “ON” will stop blinking.  icon resumes displaying. Cancel TIMER ON: Under the condition that TIMER ON is started up, press “TIMER ON” button to cancel it.







TIMER OFF button

“TIMER OFF” button can set the time for timer on. After pressing this button,  icon disappears and the word “OFF” on remote controller blinks. Press  or  button to adjust TIMER OFF setting. After each pressing  or  button, TIMER OFF setting will increase or decrease 1 minute. Hold  or  button, 2 seconds later, the time will change quickly until reaching your required time. Press “TIMER OFF” to confirm it. The word “OFF” will stop blinking.  icon resumes displaying. Cancel TIMER OFF: Under the condition that TIMER OFF is started up, press “TIMER OFF” button to cancel it.

Note:

- Under on and off status, you set TIMER OFF or TIMER ON simultaneously.
- Before setting TIMER ON or TIMER OFF, please adjust the clock time properly.



11 CLOCK button

Press this button to set clock time.  icon on remote controller will blink. Press  or  button within 5 seconds to set clock time. Each pressing of  or  button, 2 seconds later, time will change quickly. Release this button when reaching your required time. Press “CLOCK” button to confirm the time.  icon stops blinking.

Note:

- Clock time adopts 24-hour mode.
- The interval between two operation cannot exceed 5 seconds. Otherwise, remote controller will quite setting status. Operation for TIMER ON/ TIMER OFF is the same.

12 QUIET button (not available)

Press this button, the Quiet status is under the Auto Quiet mode and displays  and “AUTO” signal. Quiet mode displays  signal and during Quiet OFF

there is no  signal displayed. After powered on, the Quiet OFF is defaulted.



Note:

- The Quiet function is only available for some models.





13 WIFI button

Press “WiFi” button to turn on or off WiFi function. When WiFi function is turned on, “WiFi” icon will be displayed on remote controller. Under status of unit off, press “MODE” and “WiFi” buttons simultaneously for 1 second. WiFi module will restore to factory default setting.

14 LIGHT button

Press this button to turn off display light on indoor unit.  icon on remote controller disappears. Press this button again to turn on display light.  icon is displayed.



15  button

Press this button to achieve the on and off lonizer and scavenging (fresh air – not available) functions in operation status. Press this button for the first time to start scavenging function. LCD displays . Press the button for the second time to start lonizer and scavenging functions simultaneously. LCD displays  and . Press this button for the third time to quit lonizer and Scavenging functions simultaneously. Press the button for the fourth time to start lonizer function. LCD displays . Press this button again to repeat the operation above.

16 TEMP button

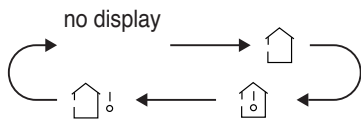
By pressing this button, you can see indoor set temperature, indoor ambient temperature or outdoor ambient temperature (not available) on indoor unit’s display. The setting on remote controller is selected circularly as below:



- When selecting  or no display with remote controller, temperature indicator on indoor unit displays set temperature.
- When selecting  with remote controller, temperature indicator on indoor unit displays indoor ambient temperature.
- When selecting  with remote controller, temperature indicator on indoor unit displays outdoor ambient temperature. (not available)

Note:

- Outdoor temperature display is not available. At that time, indoor unit receives  signal, while it displays indoor set temperature.
- It is defaulted to display set temperature when turning on the unit. There is no display in the remote controller.
- When selecting displaying of indoor or outdoor ambient temperature, indoor temperature indicator displays corresponding temperature and automatically turn to display set temperature after three of five seconds.

FUNCTION INTRODUCTION FOR COMBINANTION BUTTONS

ENERGY-SAVING FUNCTION

Under cooling mode, press “TEMP” and “CLOCK” buttons simultaneously to start up or turn off energy-saving function. When energy-saving function is started up, “SE” will be shown on remote controller and air conditioner will adjust the set temperature automatically according to ex-factory setting to reach to the best energy-saving effect. Press “TEMP” and “CLOCK” buttons simultaneously again to exit energy-saving function.

Note:

- Under energy-saving function, fan speed is defaulted at auto speed and it cannot be adjusted.
- Under energy-saving function, set temperature cannot be adjusted. Press “TURBO” button and remote controller will not send signal.
- Sleep function and energy-saving function cannot operate at the same time. If energy-saving function has been set under cooling mode, press sleep button to cancel energy-saving function. If sleep function has been set under cooling mode, start up the energy-saving function to cancel sleep function.



8 °C HEATING FUNCTION

Under heating mode, press “TEMP” and “CLOCK” buttons simultaneously to start up or turn off 8 °C heating function. When this function is started up,  and “8 °C” will be shown on remote controller. The air conditioner keeps the heating status at 8 °C. Press again “TEMP” and “CLOCK” buttons simultaneously, to cancel this function.

Note:

- Under 8 °C heating function, fan speed is defaulted at auto speed and it cannot be adjusted.
- Under 8 °C heating function, set temperature cannot be adjusted. Press “TURBO” button and the remote controller will not send signal.
- Sleep function and 8 °C heating function cannot operate at the same time. If 8 °C heating function has been set under heating mode, press sleep button to cancel 8 °C heating function. If sleep function has been set under heating mode, start up the 8 °C heating function to cancel sleep function.
- Under °F temperature display, the remote controller will display 46°F heating.

CHILD LOCK FUNCTION

Press ▲ and ▼ simultaneously to turn on or turn off child lock function. When child lock function is on,  icon is displayed on remote controller. If you operate the remote controller, icon  will blink three times without sending signal to the unit.

AUTO CLEAN FUNCTION

Under unit off status, hold “MODE” and “FAN” buttons simultaneously for 5 seconds to turn on or off the AUTO CLEAN function. When the AUTO CLEAN function is turned on, indoor displays “CL”. During the auto clean process of evaporator, the unit will perform fast cooling or fast heating. There may be some noise, which is the sound of flowing liquid or thermal expansion or cold shrinkage. The air conditioner may blow cold or warm air, which is a normal phenomenon. During cleaning process, please make sure the room is well ventilated to avoid affecting the comfort.

Note:

- The AUTO CLEAN function can only work under normal ambient temperature. If the room is dusty, clean it once a month. If not, clean it once every three months. After the auto clean function is turned on, you can leave the room. When auto clean is finished, the air conditioner will enter standby status.

TEMPERATURE DISPLAY SWITCHOVER FUNCTION

Under OFF status, press ▼ and “MODE” buttons simultaneously to switch temperature display between °C and °F.

BASIC OPERATION GUIDE

- 1 After putting through the power, press “ON/OFF” button or remote controller to turn on the air conditioner. Press it again to turn it off.
- 2 Press “MODE” button to select your required mode: AUTO, COOL, DRY, FAN, HEAT.
- 3 Press ▲ or ▼ button to set your required temperature. Temperature cannot be adjusted under auto mode.
- 4 Press “FAN” button to set your required fan speed: auto, low speed, low-medium speed, medium speed, medium-high speed, high speed.
- 5 Press ⇨ button to select fan blowing angle.

REPLACEMENT OF BATERIES IN REMOTE CONTROLLER

- 1 Press the back side of remote controller marked with and then push out the cover of battery box along the arrow direction.
- 2 Replace two 7# (AAA 1.5V) dry batteries, and make sure the position of “+” and “-” polar are correct.
- 3 Reinstall the cover of battery box.

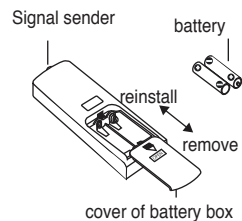

NOTICE:

- During operation, point the remote control signal sender at the receiving window on indoor unit.
- The distance between signal sender and receiving window should be no more than 8 m, and there should be no obstacles between them.
- Signal may be interfered easily in the room where there is fluorescent lamp or wireless telephone; remote controller should be close to indoor unit during operation.
- Replace new batteries of the same model when replacement is required.
- When you do not use remote controller for a long time, please take out the batteries.
- If the display on remote controller is fuzzy or there is no display, please replace batteries.

Emergency operation

If remote controller is lost or damaged, please use auxiliary button to turn

on or turn off the air conditioner. The operation in details are as below. Open panel, press aux button to turn on or turn off the air conditioner. When the air conditioner is turned on, it will operate under Auto mode.

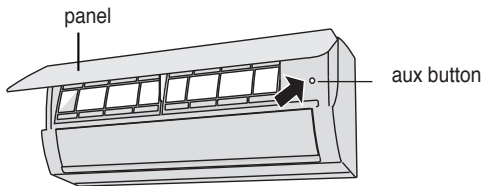

! WARNING

Use insulated object to press the auto button.

CLEAN AND MAINTENANCE

! WARNING

- Turn off the air conditioner and disconnect the power before cleaning the air conditioner to avoid electric shock.
- DO NOT wash the air conditioner with water to avoid electric shock.
- DO NOT use volatile liquid to clean the air conditioner.

Clean surface of indoor unit

When the surface of indoor unit is dirty, it is recommended to use a soft dry cloth or wet cloth to wipe it.

Notice: Do not remove the panel when cleaning it.

Clean Filter

1. Open panel.

Pull out the panel to a certain angle as shown in the fig.

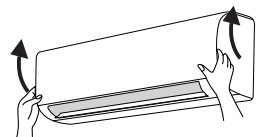

2. Remove filter.

Remove filter as indicated in the fig.

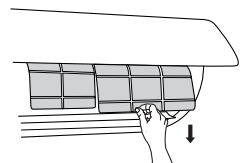

3. Clean filter.

- Use dust catcher or water to clean the filter.
- When the filter is very dirty, use the water (below 45°C) to clean it, and then put it in a shady and cool place to dry.

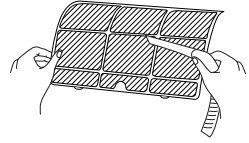

4. Install filter.

Install properly the filter and then close panel cover tightly.

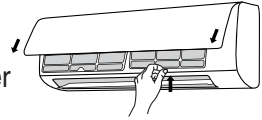

WARNING

- Filter must be cleaned every three months. If there is much dust in the operation environment cleaning frequency is recommended.
- After removing the filter, do not touch fins to avoid injury.
- DO NOT use fire or hair dryer to dry the filter. This may cause deformation or fire hazard.
- DO NOT clean the healthy filters with water. These filters must be cleaned only with a vacuum cleaner or simply by shaking them on the balcony.

Note: Basic points that needs to be checked before use in case you have not used for a long time the air conditioner.

1. Check whether air inlets and air outlets are blocked.
2. Check whether air switch, plug and socket are in good condition.
3. Check whether filter is clean.
4. Check whether mounting bracket for outdoor unit is damaged or corroded. If yes, please contact dealer.
5. Check whether drainage pipe is damaged.

Note: Basic points that needs to be checked before you stop using your air conditioner for a long time.

1. Disconnect power supply.
2. Clean filter and front panel of indoor unit.
3. Check whether mounting bracket for outdoor unit is damaged or corroded. If yes, please contact dealer.

Notice for recycling

1. Many packing materials are recyclable materials. Please dispose them in appropriate recycling unit.
2. If you want to dispose the air conditioner, please contact local dealer or consultant service center for the correct disposal method.

MALFUNCTION ANALYSIS

General phenomenon analysis

Please check below items before asking for maintenance. If the malfunction still cannot be eliminated, please contact local dealer or qualified professionals.

TROUBLE – CAUSE – SOLUTION

Phenomenon	Check for	Solution
Indoor unit cannot receive remote controller's signal or remote controller has no action.	Whether it is interfered severely (such as static electricity, stable voltage)?	Pull out the plug. Reinsert the plug after about 3 minutes, and then turn on the unit again.
	Whether remote controller is within the signal receiving range?	Signal receiving range is 8 m.
	Whether there are obstacles?	Remove obstacles.
	Whether remote controller is pointing at the receiving window?	Select proper angle and point the remote controller at the receiving window on indoor unit.
	Is sensitivity of remote controller low; fuzzy display and no display?	Check the batteries. If the power of batteries is too low, please replace them.
	No display when operating remote controller?	Check whether remote controller appears to be damaged. If yes, replace it.
	Fluorescent lamp in room?	<ul style="list-style-type: none"> • Take the remote controller close to indoor unit. • Turn off the fluorescent lamp and then try it again.

Phenomenon	Check for	Solution
No air emitted from indoor unit.	Air inlet or air outlet of indoor unit is blocked?	Remove obstacles.
	Under heating mode, indoor temperature is reached to set temperature?	After reaching to set temperature, indoor unit will stop blowing out air.
	Heating mode is turned on just now?	In order to prevent blowing out cold air, indoor unit will be started after delaying for several minutes, which is a normal phenomenon.
Air conditioner cannot operate.	Power failure?	Wait until power recovery.
	Is plug loose?	Reinsert the plug.
	Air switch trips off or fuse is burnt out?	Ask professional to replace air switch or fuse.
	Wiring has malfunction?	Ask professional to replace it.
	Unit has restarted immediately after stopping operation?	Wait for 3 minutes, and then turn on the unit again.
	Whether the function setting for remote controller is correct?	Reset the function.
Mist is emitted from indoor unit's air outlet.	Indoor temperature and humidity is high?	Because indoor air is cooled rapidly. After a while, indoor temperature and humidity will be decrease and mist will disappear.
Set temperature cannot be adjusted.	Unit is operating under auto mode?	Temperature cannot be adjusted under auto mode. Please switch the operation mode if you need to adjust temperature.
	Your required temperature exceeds the set temperature range?	Set temperature range: 16°C ~ 30°C.

Phenomenon	Check for	Solution
Cooling/Heating effect is not good.	Voltage is too low?	Wait until the voltage resumes normal.
	Filter is dirty?	Clean the filter.
	Set temperature is in proper range?	Adjust temperature to proper range.
	Door and window are open?	Close door and window.
Odours are emitted.	Whether there is odour source, such as furniture and cigarette, etc?	<ul style="list-style-type: none"> • Eliminate the odour source. • Clean the filter.
Air Conditioner suddenly turned on.	Whether there is interference, such as thunder, wireless devices, etc.?	Disconnect power, put back power, and then turn on the unit again.
Outdoor unit has vapor.	Heating mode is turned on?	During defrosting under heating mode, it may generate vapor, which is a normal phenomenon.
“Water flowing” noise.	Air conditioner is turned on or turned off just now?	The noise is the sound of refrigerant flowing inside the unit, which is a normal phenomenon.
Cracking noise.	Air conditioner is turned on or turned off just now?	This is the sound of friction caused by expansion and/or contraction of panel or other parts due to the change of temperature.

Error Code

When air conditioner status is abnormal, temperature indicator on indoor unit will blink to display corresponding error code. Please refer to below list for identification of error code.

Error code	Troubleshooting
E5, E8, U8, H6, H3, E1	It can be eliminated after restarting the unit. If not, please contact qualified professional for service.
C5, F1, F2, F0	Please contact authorized qualified technician.

Note: If there are other error codes, please contact qualified professionals for service.

Please turn off the air conditioner, take out the plug and contact the authorized licensed technician G.E.DIMITRIOU SA, tel ☎ +30 210 5386490 in case a problem of below notes occurs.

WARNING

- When below phenomenon occurs, please turn off air conditioner and disconnect power immediately and then contact the dealer or qualified professional for service.
- Power cord is overheating or damaged.
- There is abnormal sound during operation.
- Air switch trips off frequently.
- Air conditioner gives off burning smell.
- There is a leakage from the indoor unit.
- DO NOT repair or refit the air conditioner by yourself.
- If the air conditioner operates under abnormal conditions, it may cause malfunction, electric shock or fire hazard.

INSTALLATION DIMENSION DIAGRAM

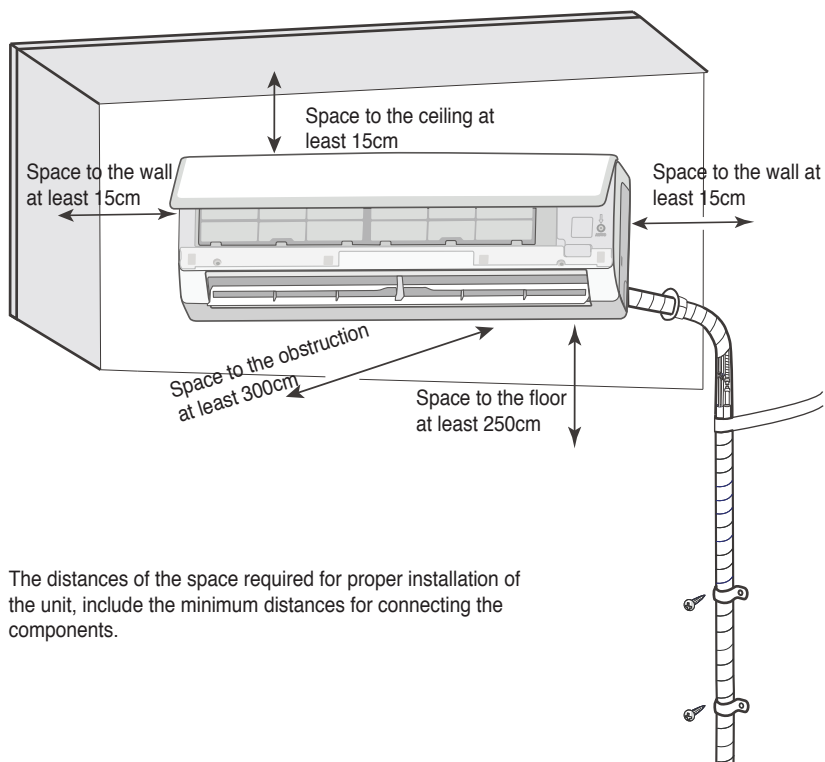

The distances of the space required for proper installation of the unit, include the minimum distances for connecting the components.

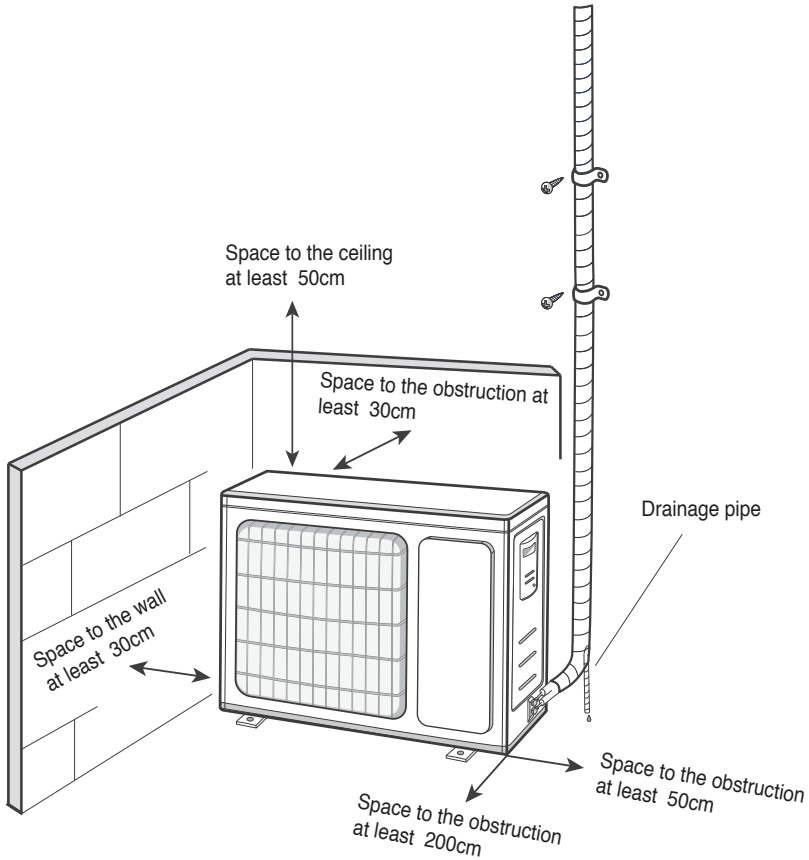

Tools for installation

Level meter	Screw driver	Impact drill
Drill head	Pipe expander	Torque wrench
Open-end wrench	Pipe cutter	Leakage detector
Vacuum pump	Pressure meter	Universal meter
Inner hexagon spanner		Measuring tape

Note:

- Please contact the local agent for installation.
- DO NOT use unqualified power cord.

Selection of installation location

Basic requirement

Installing the unit in the following places may cause malfunction. If it is unavoidable, please consult the local dealer.

1. The place with strong heat sources, vapors, flammable or explosive gas, or volatile objects spread in the air.
2. The place with high-frequency devices (such as welding machine, medical equipment).
3. The place near coast area.
4. The place with oil or fumes in the air.
5. The place with sulfureted gas.
6. Other places with special circumstances.
7. The appliance shall not be installed in the laundry.
8. It is not allowed to be installed on the unstable or motive based structure (such as a truck) or in the corrosive environment (such as chemical factory).

Indoor unit

1. There should be no obstruction near air inlet and air outlet.
2. Select a location where the condensation water can be dispersed easily and will not affect other people.
3. Select a location which is convenient to connect the outdoor unit and near the power socket.
4. Select a location which is out of reach for children.
5. The location should be able to with stand the weight of indoor unit and will not increase noise and vibration.
6. The appliance must be installed 2.5 m.
7. DO NOT install the indoor unit right above the electric appliance.
8. Please try your best to keep way from fluorescent lamp.

Outdoor unit

1. Select a location where the noise and outflow air emitted by the outdoor unit will not affect neighborhood.
2. The location should be well ventilated and dry, in which the outdoor unit will not be exposed directly to sunlight or strong wind.
3. The location should be able to withstand the weight of outdoor unit.
4. Make sure that the installation follows the requirement of installation dimension diagram.
5. Select a location which is out of reach for children and far away from animals or plants. If it is unavoidable, please add the fence for safety purpose.

SAFETY PRECAUTION

1. Must follow the electric safety regulations when installing the unit.
2. According to the local safety regulations, use qualified power supply circuit and air switch.
3. Make sure the power supply matches with the requirement of air conditioner. Unstable power supply or incorrect wiring may result in electric shock, fire hazard or malfunction. Please install proper power supply cables before using the air conditioner.
4. Properly connect the live wire, neutral wire and grounding wire of power socket.
5. Be sure to cut off the power supply before proceeding any work related to electricity and safety.
6. Do not put through the power before finishing installation.
7. If the supply cord is damaged, it must be replaced by the manufacturer, its service agent or similarly qualified persons in order to avoid a hazard.
8. The temperature of refrigerant circuit will be high, please keep the interconnection cable away from the copper tube.
9. The appliance shall be installed in accordance with national wiring regulations.



Please notice that the unit is filled with flammable gas R32. Inappropriate treatment of the unit involves the risk of severe damages of people and material. Details to this refrigerant are found in chapter “refrigerant”.

GROUNDING REQUIREMENT

1. The air conditioner is the first class electric appliance. It must be properly grounding with specialized grounding device by a professional. Please make sure it is always grounded effectively, otherwise it may cause electric shock.
2. The yellow-green wire in air conditioner is grounding wire, which cannot be used for other purposes.
3. The grounding resistance should comply with national electric safety regulations.
4. The appliance must be positioned so that the plug is accessible.
5. An all-pole disconnection switch having a contact separation of at least 3 mm in all poles should be connected in fixed wiring.

Including an air switch with suitable capacity, please note the following table. Air switch should be included magnet buckle and heating buckle function, it can protect the circuit-short and overload. (Caution: please do not use the fuse only for protecting the circuit).

Air-conditioner	Air switch capacity
9K & 12K	10A
17K & 21K	16A

Installation of indoor unit

Step one: Choosing installation location

Recommend the installation location and confirm it with client.

Step two: Install wall-mounting frame

1. Hang the wall-mounting frame on the wall; adjust it in horizontal position with the level meter and then point out the screw fixing holes on the wall.
2. Drill the screw fixing holes on the wall with impact drill (the specifications

of drill head should be same as the plastic expansion particle) and then fill the plastic expansion particles in the holes.

3. Fix the wall-mounting frame on the wall with tapping screws and then check if the frame is firmly installed by pulling the frame. If the plastic expansion particle is loose, please drill another fixing hole nearby.

Step three: Open piping hole

1. Choose the position of piping hole according to the direction of outlet pipe. The position of piping hole should be a little lower than the wall-mounted frame, shown as below.

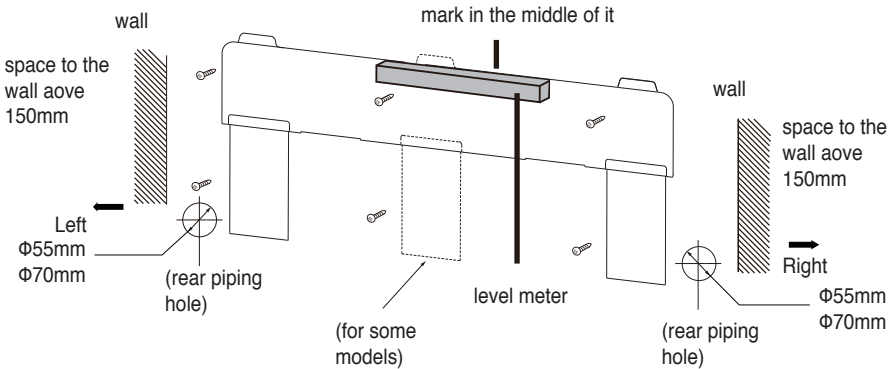

NOTE:

- The wall panel is for illustrative purposes only, please refer to the actual installation.
 - The wall panel is for illustrative purposes only, please refer to the actual installation. Please refer to the actual circumstances for the number of screws and the position of screws.
2. When installation is finished, pull the mounting nut with torque wrench. Plate with hand to confirm whether it is fixed tightly. The force distribution for all screws should be uniform.
 3. Open a piping hole with the diameter of $\Phi 55$ or $\Phi 70$ on the selected outlet pipe position. In order to drain smoothly, slant the piping hole on the wall slightly downward to the outdoor side with the gradient of 5-10°.

Note:

- Pay attention to dust prevention and take relevant safety measures when opening the hole.
- The plastic expansion particles are not provided and should be bought locally.

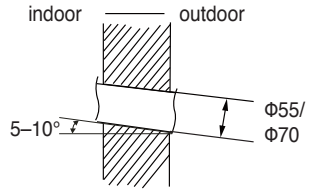

Step four: Outlet pipe

1. The pipe can be led out in the direction of right, rear right, left or rear left.
2. When select leading out the pipe from left or right, please cut off the corresponding hole on the bottom case.

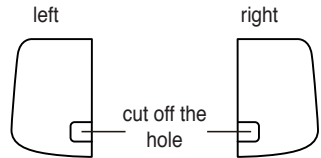
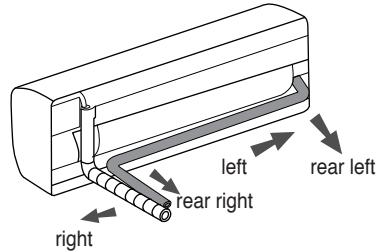

Step five: Connect the pipe of indoor unit

1. Aim the pipe joint at the corresponding Bellmouth.
2. Pretightening the union nut with hand.
3. Adjust the torque force by referring to the following sheet. Place the open-end wrench on the pipe joint and place the torque wrench on the union nut. Tighten the union nut with torque wrench.

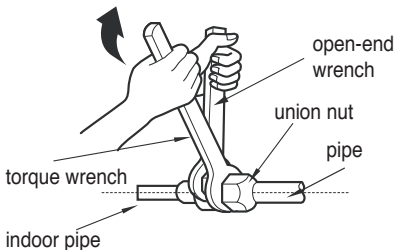
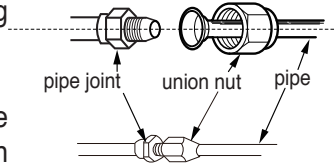

Hex nut diameter	tightening torque (N-m)
1/4"	15~20
3/8"	30~40
1/2"	45~55
5/8"	60~65
3/4"	70~75

4. Wrap the indoor pipe and joint of connection pipe with insulating pipe, and then wrap it with tape.

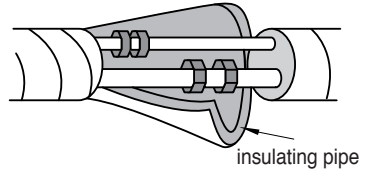

Step six: Install drain hose

1. Connect the drain hose to the outlet pipe of indoor unit.

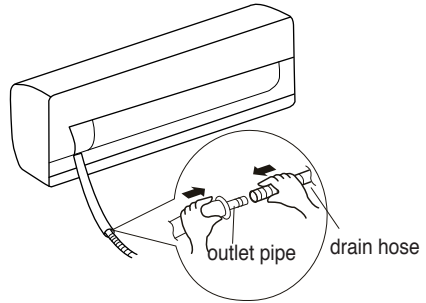

2. Bind the joint with tape.

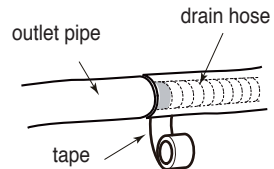

Note:

- Add insulating pipe in the indoor drain hose in order to prevent condensation.
- The plastic expansion particles are not provided.

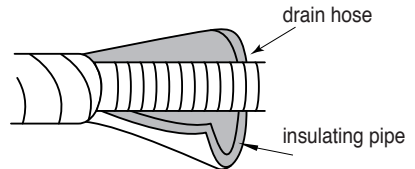

Step seven: Connect wire of indoor unit

Note:

- All wires of indoor unit and outdoor unit should be connected by a professional.
- If the length of power connection wire is insufficient, please contact the supplier for a new one. DO NOT extend the wire by yourself.
- For the air conditioner with plug, make sure that the plug is reachable after installation.
- For the air conditioner without plug, an air switch must be installed in the line. The air switch should be all-pole parting and the contact parting distance should be more than 3 mm.

1. Open the panel, remove the screw on the wiring cover and then take down the cover.

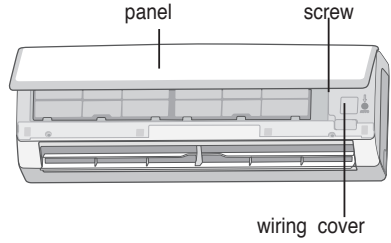

2. Make the power connection wire go through the cable-cross hole at the back of indoor unit and then pull it out from the front side.

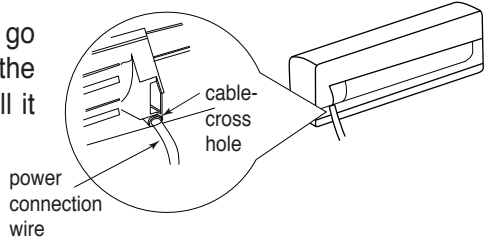

3. Remove the wire clip; connect the power connection wire to the wiring terminal according to the color; tighten the screw and then fix the power connection wire with wire clip.

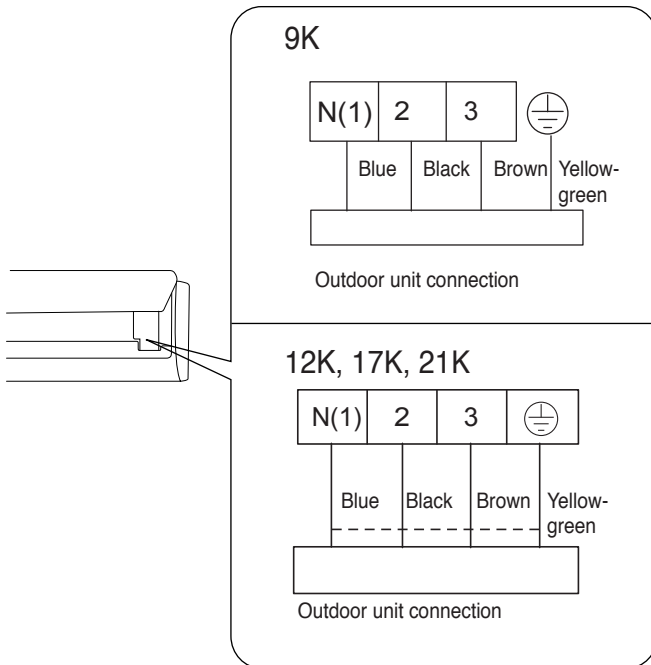

Note: The wiring board is for reference only, please refer to the actual one.

4. Put wiring cover back and then tighten the screw.
5. Close the panel.

Step eight: Bind up pipe

1. Bind up the connection pipe, power cord and drain hose with the band.

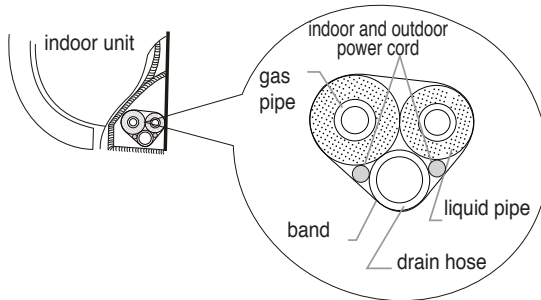

2. Reserve a certain length of drain hose and power cord for installation when binding them. When binding to a certain degree, separate the indoor power and then separate the drain hose.

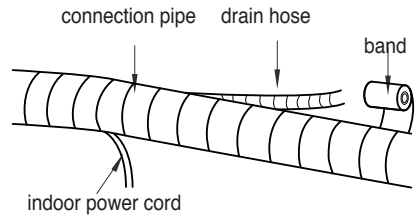

3. Bind them evenly.
4. The liquid pipe and gas pipe should be bound separately at the end.

Note:

- The power cord and control wire cannot be crossed or winding.
- The drain hose should be bound at the bottom.

Step nine: Hang the indoor unit

1. Put the bound pipes in the wall pipe and then make them pass through the wall hole.
2. Hang the indoor unit on the wall-mounting frame.
3. Stuff the gap between pipes and wall hole with sealing gum.

4. Fix the wall pipe.
5. Check if the indoor unit is installed firmly and closed to the wall.

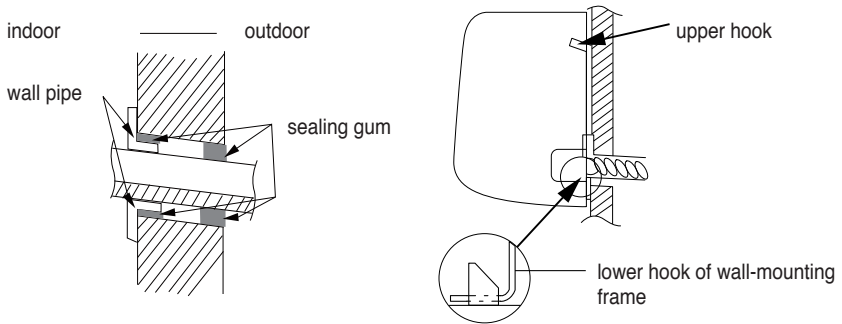

Note:

- Do not bend the drain hose too excessively in order to prevent blocking.

INSTALLATION OF OUTDOOR UNIT

**Step one: Fix the support of outdoor unit
(select it according to the actual installation situation)**

1. Select installation location according to the house structure.
2. Fix the support of outdoor unit on the selected location with expansion screws.

Note:

- Take sufficient protective measures when installing the outdoor unit.
- Make sure the support can withstand at least four times of the unit weight.
- The outdoor unit should be installed at least 3 cm above the floor in order to install drain joint.
- For the unit with cooling capacity of 2300W~5000W, 6 expansion screws are needed; for the unit with cooling capacity of 6000W~8000W, 8 expansion screws are needed; for the unit with cooling capacity of 10000W ~16000W, 10 expansion screws are needed.

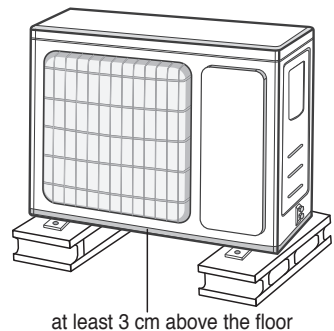

Step two: Install drain joint

1. Connect the outdoor drain joint into the hole on the chassis, as shown in the picture below.
2. Connect the drain hose into the drain vent.

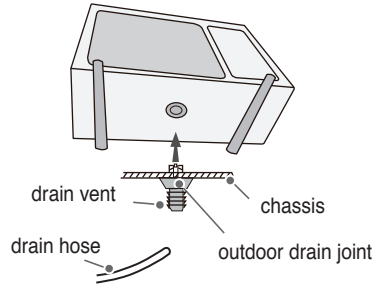

Note: As for the shape of drainage joint, please refer to the current product. Do not install the drainage joint in the severe cold area. Otherwise, it will be frosted and then cause malfunction.

Step three: Fix outdoor unit

1. Place the outdoor unit on the support.
2. Fix the foot holes of outdoor unit with bolts.

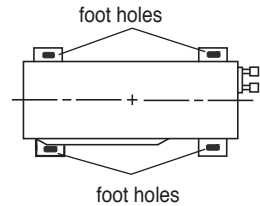

Step four: Connect indoor and outdoor pipes

1. Remove the screw on the right handle of outdoor unit and then remove the handle.

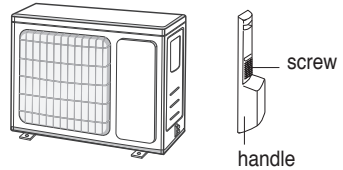

Note: When there are multiple cables passing through it, the cross-hole of handle should be knocked off and eliminate the sharp burrs for avoid damaging the cables.



2. Remove the screw cap of valve and aim the pipe joint at the bellmouth of pipe.

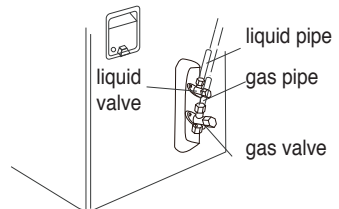

3. Pretightening the union nut with hand.

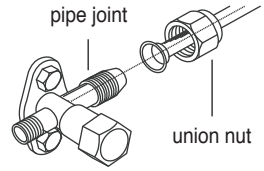

4. Tighten the union nut with torque wrench by referring to the sheet below.

Hex nut diameter	Tightening torque (N-m)
1/4"	15~20
3/8"	30~40
1/2"	45~55
5/8"	60~65
3/4"	70~75

Step five: Connect outdoor electric wire

1. Remove the wire clip; connect the power connection wire and signal control wire (only for cooling and heating unit) to the wiring terminal according to the color; fix them with screws.

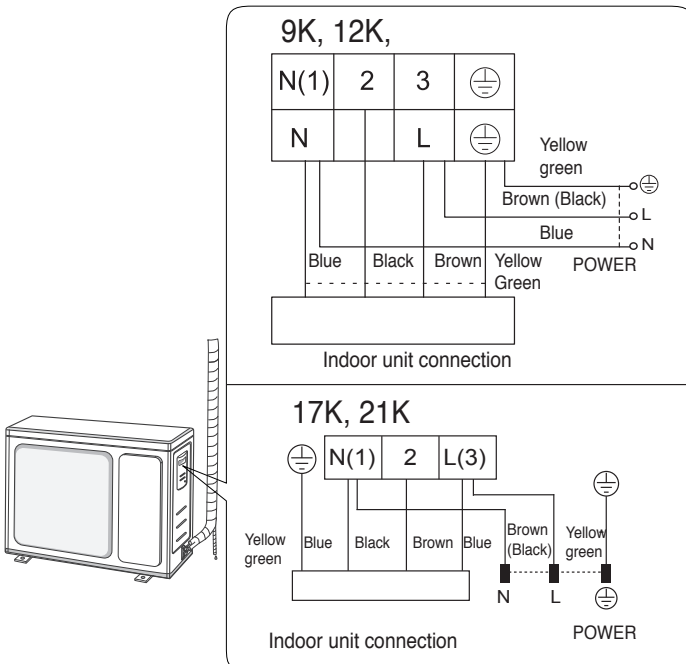

Note: The wiring board is for reference only. Please refer to the actual one.

2. Fix the power connection wire and signal control wire with wire clip (only for cooling and heating unit).

Note:

- After tightening the screw, pull the power cord slightly to check if it is firm.
- Never cut the power connection wire to prolong or shorten the distance.

Step six: Neaten the pipes

1. The pipes should be placed along the wall, bent reasonably and hidden possibly. Min. semidiameter of bending the pipe is 10 cm.
2. If the outdoor unit is higher than the wall hole, you must set a U-shaped curve in the pipe before pipe goes into the room, in order to prevent rain from getting into the room.

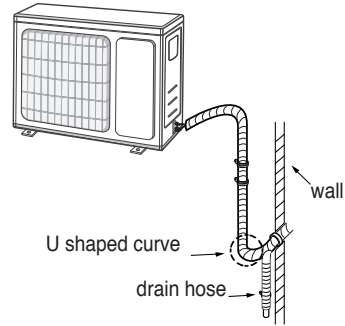

Note:

The trough-wall height of drain hose should be higher than the outlet pipe hole of indoor unit.

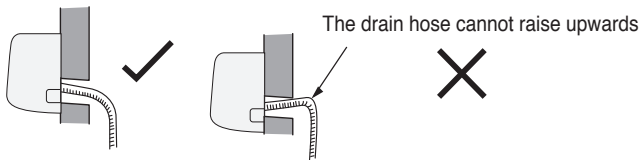

The water outlet cannot be placed in water in order to drain smoothly.

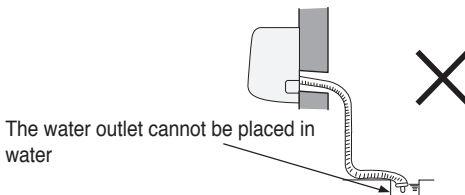

Slant the drain hose slightly downwards. The drain hose cannot be curved, raised and fluctuant etc.

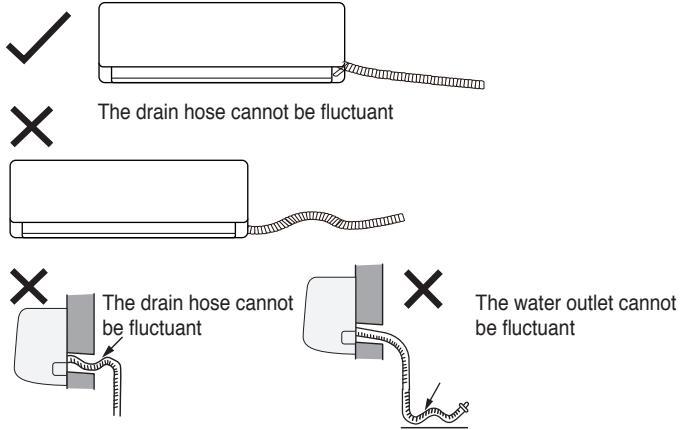

VACUUM PUMPING

1. Remove the valve caps on the liquid valve and gas valve and the nut of refrigerant charging vent.
2. Connect the charging hose of piezometer to the refrigerant charging vent of gas valve and then connect the other charging hose to the vacuum pump.
3. Open the piezometer completely and operate for 10-15 minutes to check if the pressure of piezometer remains in -0.1MPa .
4. Close the vacuum pump and maintain this status for 1-2 minutes to check if the pressure of piezometer remains in -0.1MPa . If the pressure decreases, there may be leakage.
5. Remove the piezometer, open the valve core of liquid valve and gas valve completely with inner hexagon spanner.
6. Tighten the screw caps of valves and refrigerant charging vent.
7. Reinstall the handle.

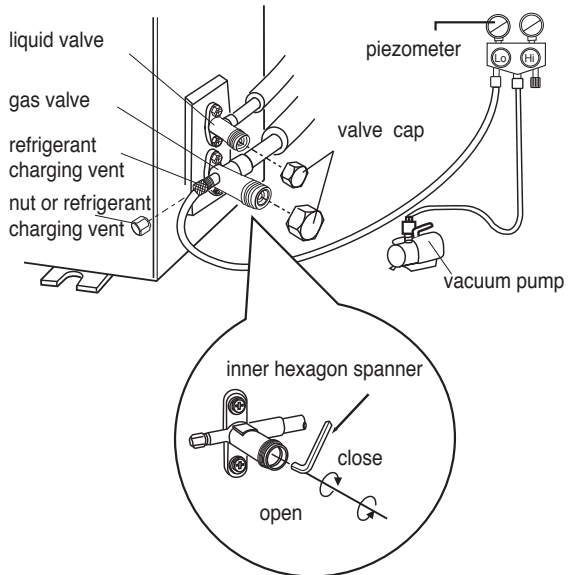

OPERATION TEST

Pipe expanding method

Note:

Improper pipe expanding is the main cause of refrigerant leakage. Please expand the pipe according to the following steps:

A: Cut the pipe

- Confirm the pipe length according to the distance of indoor unit and outdoor unit.
- Cut the required pipe with pipe cutter.

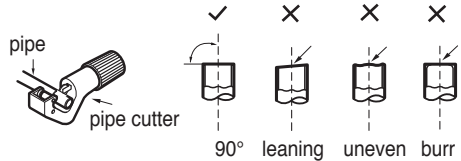

B. Remove the burrs

- Remove the burrs with shaper and prevent the burrs from getting into the pipe.

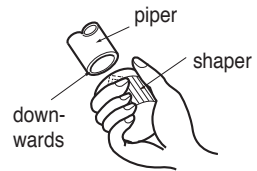

C. Put on suitable insulating pipe.

D. Put on the unit nut.

- Remove the union nut on the indoor connection pipe and outdoor valve; install the union nut on the pipe.

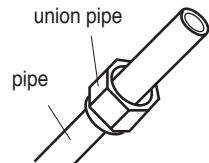

E: Expand the port

- Expand the port with expander.

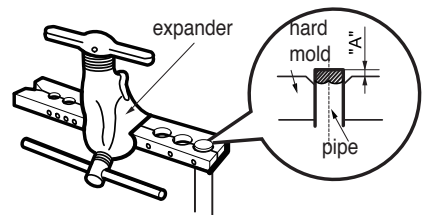

Note:

- «A» is different according to the diameter, please refer to the sheet below:

Outer diameter (mm)	A (mm) Maximum	A (mm) Minimum
Φ6 – 6.35 (1/4")	1.3	0.7
Φ9.52 (3/8")	1.6	1.0
Φ12 – 12.7 (1/2")	1.8	1.0
Φ15.8 – 16 (5/8")	2.4	2.2

F: Inspection

- Check the quality of expanding port. If there is any blemish, expand the port again according to the steps above.

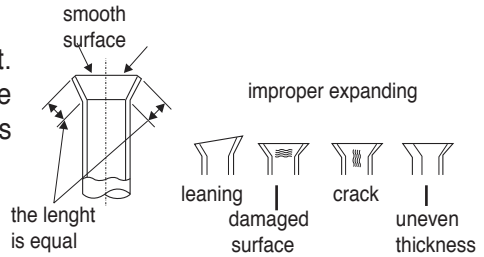

LEAKAGE DETECTION

- With leakage detector:
Check if there is leakage with leakage detector.
- With soap water:
If leakage detector is not available, please use soap water for leakage detection. Apply soap water at the suspected position and keep the soap water for more than 3 minutes. If there are air bubbles coming out of this position, there is a leakage.

Test operation

1. Preparation of test operation

- Specify the important notes for air conditioner to the client.

2. Method of test operation

- Put through the power, press ON/OFF button on the remote controller to start operation.
- Press MODE button to select AUTO, COOL, DRY, FAN and HEAT to check whether the operation is normal or not.
- If the ambient temperature is lower than 16°C, the air conditioner cannot start cooling.

CONFIGURATON OF CONNECTION PIPE

- Standard length of connection pipe 5 m, 7.5 m, 8 m.
- Minimum length of connection pipe 3 m.
- Maximum length of connection pipe as below:

Cooling Capacity	Max length of connection pipe
5000 (BTU/h) (1465W) 7000 (BTU/h) (2051W) 9000 (BTU/h) (2637W)	15
12000 (BTU/h) (3516W)	20
18000 (BTU/h) (5274W) 24000 (BTU/h) (7032W)	25
28000 (BTU/h) (8204W) 36000 (BTU/h) (10548W) 42000 (BTU/h) (12306W) 48000 (BTU/h) (14064W)	30

4. The additional refrigerant oil and refrigerant charging required after prolonging connection pipe.

- After the length of connection pipe is prolonged for 10 m at the basis of standard length, you should add 5 ml of refrigerant oil for each additional 5 m of connection pipe. The calculation method of additional refrigerant charging amount (on the basis of liquid pipe).
- Additional refrigerant charging amount = prolonged length of liquid pipe x additional refrigerant charging amount per meter.
- Basing on the length of standard pipe, add refrigerant according to the requirement as shown in the table. The additional refrigerant charging amount per meter is different according to the diameter of liquid pipe. See the following sheet.

Configuration of connection pipe

Diameter of connection pipe mm		Indoor unit throttle	Outdoor unit throttle	
Liquid pipe	Gas pipe	Cooling only, cooling and heating (g / m)	Cooling only (g / m)	Cooling and heating (g / m)
1/4"	3/8" or 1/2"	16	12	16
1/4" or 3/8"	5/8" or 3/4"	40	12	40
1/2"	3/4" or 7/8"	80	24	96
5/8"	1" or 1 1/4"	136	48	96
3/4"	-	200	200	200
7/8"	-	280	280	280

Note: The additional refrigerant charging amount in Sheet 2 is recommended value, not compulsory.

Safety operation of flammable refrigerant

Qualification requirement for installation and maintenance man

- All the work men who are engaging in the refrigeration system should bear the valid certification awarded by the authoritative organization and the qualification for dealing with the refrigeration system recognized by this industry. If it needs other technician to maintain and repair the appliance, they should be supervised by the person who bears the qualification for using the flammable refrigerant.
- It can only be repaired by the method suggested by the equipment's manufacturer.

INSTALLATION NOTES

- The air conditioner is not allowed to use in a room that has running fire (such as fire source, working coal gas ware, operating heater).
- It is not allowed to drill hole or burn the connection pipe.
- The air conditioner must be installed in a room that is larger than the minimum room area. The minimum room area is shown on the nameplate or following table a.
- Leak test is a must after installation.

Table a - Minimum room area (m²)

Minimum room area (m ²)	Charge amount (kg)	≤1.2	1.3	1.4	1.5	1.6	1.7	1.8
	Floor location	/	14.5	16.8	19.3	22	24.8	27.8
	Window mounted	/	5.2	6.1	7	7.9	8.9	10
	Wall mounted	/	1.6	1.9	2.1	2.4	2.8	3.1
	Ceiling mounted	/	1.1	1.3	1.4	1.6	1.8	2.1

Minimum room area (m ²)	Charge amount (kg)	1.9	2	2.1	2.2	2.3	2.4	2.5
	Floor location	31	34.3	37.8	41.5	45.4	49.4	53.6
	Window mounted	11.2	12.4	13.6	15	16.3	17.8	19.3
	Wall mounted	3.4	3.8	4.2	4.6	5	5.5	6
	Ceiling mounted	2.3	2.6	2.8	3.1	3.4	3.7	4

MAINTENANCE NOTES

- Check whether the maintenance area or the room area meet the requirement of the nameplate.
- It is only allowed to be operated in the rooms that meet the requirement of the nameplate.
- Check whether the maintenance area is well-ventilated.
- The continuous ventilation status should be kept during the operation process.
- Check whether there is fire source or potential fire source in the maintenance area.
- The naked flame is prohibited in the maintenance area; and the “no smoking” warning board should be hanged.
- Check whether the appliance mark is in good condition.
- Replace the vague or damaged warning mark.

WELDING

- If you should cut or weld the refrigerant system pipes in the process of maintaining, please follow the steps as below:
 - a. Shut down the unit and cut power supply.
 - b. Eliminate the refrigerant.
 - c. Vacuuming
 - d. Clean it with N2 gas
 - e. Cutting or welding
 - f. Carry back to the service spot for welding
- The refrigerant should be recycled into the specialized storage tank.
- Make sure that there is not any naked flame near the outlet of the vacuum pump and it is well-ventilated.

FILLING THE REFRIGERANT

- Use the refrigerant filling appliances specialized for R32. Make sure that different kinds of refrigerant will not contaminate with each other.
- The refrigerant tank should be kept upright at the time of filling refrigerant.
- Stick the label on the system after filling is finished (or have not finished).
- DO NOT overfilling.
- After filling is finished, please do the leakage detection before test running; Another time of leak detection should be done when it is removed.

SAFETY INSTRUCTIONS FOR TRANSPORTATION AND STORAGE

- Please use the flammable gas detector to check before unload and open the container.
- No fire source and smoking.
- According to the local rules and laws.

Safety instructions when installing or moving the unit

To ensure the safety of you as well as the device, please follow the safety instructions below.

CHECK AFTER INSTALLATION

- Check according to the following requirement after finishing installation.

Items to be checked	Possible malfunction
Has the unit been installed firmly?	The unit may drop, shake or emit noise.
Have you done the refrigerant leakage test?	It may cause insufficient cooling or heating capacity.
Is heat insulation of pipeline sufficient?	It may cause condensation and water dripping.
Is water drained well?	It may cause condensation and water dripping.
Is the voltage of power supply according to the voltage marked on the nameplate?	It may cause malfunction or damaging the parts.
Is electric wiring and pipeline installed correctly?	It may cause malfunction or damaging the parts.
Is the unit grounded securely?	It may cause electric leakage.

Items to be checked	Possible malfunction
Does the power follow the specification?	It may cause malfunction or damaging the parts.
Is there any obstruction in the air inlet and outlet?	It may cause insufficient cooling or heating capacity.
The dust and sundries caused during installation are removed?	It may cause malfunction or damaging the parts.
The gas valve and liquid valve of connection pipe are open completely?	It may cause insufficient cooling or heating capacity.
Is the inlet and outlet of piping hole been covered?	It may cause insufficient cooling or heating capacity or waster electricity.

Safety precautions for installing and relocating the unit

To ensure safety, please be mindful of the following precautions.

WARNING

1. When installing or relocating the unit, be sure to keep the refrigerant circuit free from air or substances other than the specified refrigerant.

Any presence of air or other foreign substance in the refrigerant circuit will cause system pressure rise or compressor rupture, resulting in injury.

2. When installing or moving the unit, do not charge the refrigerant which is not comply with that on the nameplate or unqualified refrigerant.

Otherwise, it may cause abnormal operation, wrong action, mechanical malfunction or even series safety accident.

3. When refrigerant needs to be recovered during relocating or repairing the unit, be sure that the unit is running in cooling mode.

Then, fully close the valve at high pressure side (liquid valve). About 30-40 seconds later, fully close the valve at low pressure side (gas valve), immediately stop the unit and disconnect power. Please not that the time for refrigerant recovery should not exceed 1 minute. If refrigerant recovery takes too much time, air may be sucked in and cause pressure rise or compressor rupture, resulting in injury.

4. During refrigerant recovery, make sure that liquid valve and gas valve are fully closed and power is disconnected before detaching the connection pipe.

connection pipe is not yet connected, air will be sucked in and cause pressure rise or compressor rupture, resulting in injury.

5. When installing the unit, make sure that connection pipe is securely connected before the compressor starts running. If compressor starts running when stop valve is open and connection pipe is not yet connected, air will be sucked in and cause pressure rise or compressor rupture, resulting in injury.

6. Prohibit installing the unit at the place where there may be leaked corrosive gas or flammable gas. If there are leaked gasses around the unit, it may cause explosion and other accidents.

7. Do not use extension cords for electrical connections. If the electric wire is not long enough, please contact a local authorized service center and ask for a proper electric wire. Poor connections may lead to electric shock or fire.

8. Use the specified types of wires for electrical connections between the indoor and outdoor units. Firmly clamp the wires so that their terminals receive not external stresses. Electric wires with insufficient capacity, wrong wire connections and insecure wire terminals may cause electric shock or fire.

SPECIALIST'S MANUAL

- **Repair to intrinsically safe components**

Do not apply any permanent inductive or capacitance loads to the circuit without ensuring that this will not exceed the permissible voltage and current permitted for the equipment in use.

Intrinsically safe components are the only types that can be worked on while live in the presence of a flammable atmosphere. The test apparatus shall be at the correct rating.

Replace components only with parts specified by the manufacturer. Other parts may result in the ignition of refrigerant in the atmosphere from a leak.

- **Cabling**

Check that cabling will not be subject to wear, corrosion, excessive pressure, vibration, sharp edges or any other adverse environmental effects. The check

shall also take into account the effects of aging or continual vibration from sources such as compressors or fans.

- **Detection of flammable refrigerants**

Under no circumstances shall potential sources of ignition be used in the searching for or detection of refrigerant leaks. A halide torch (or any other detector using a naked flame) shall not be used.

- **Leak detection methods**

Leak detection fluids are suitable for use with most refrigerants but the use of detergents containing chlorine shall be avoided as the chlorine may react with the refrigerant and corrode the copper pipe-work.

- **Decommissioning**

Before carrying out this procedure, it is essential that the technician is completely familiar with the equipment and all its detail. It is recommended good practice that all refrigerants are recovered safely.

Prior to the task being carried out, an oil and refrigerant sample shall be taken in case analysis is required prior to re-use of reclaimed refrigerant. It is essential that electrical power is available before the task is commenced.

- a) Become familiar with the equipment and its operation.
- b) Isolate system electrically.
- c) Before attempting the procedure, ensure that:
 - mechanical handling equipment is available, if required, for handling refrigerant cylinders;
 - all personal protective equipment is available and being used correctly;
 - the recovery process is supervised at all times by a competent person;
 - recovery equipment and cylinders conform to the appropriate standards.
- d) Pump down refrigerant system, if possible.
- e) If a vacuum is not possible, make a manifold so that refrigerant can be removed from various parts of the system.
- f) Make sure that cylinder is situated on the scales before recovery takes place.
- g) Start the recovery machine and operate in accordance with manufacturer's instructions.
- h) Do not overfill cylinders. (No more than 80% volume liquid charge).
- i) Do not exceed the maximum working pressure of the cylinder, even temporarily.

- j) When the cylinders have been filled correctly and the process completed, make sure that the cylinders and the equipment are removed from site promptly and all isolation valves on the equipment are closed off.
- k) Recovered refrigerant shall not be charged into another refrigeration system unless it has been cleaned and checked.

- **Labelling**

Equipment shall be labelled stating that it has been de-commissioned and emptied of refrigerant. The label shall be dated and signed. For appliances containing flammable refrigerants, ensure that there are labels on the equipment stating the equipment contains flammable refrigerant.

- **Recovery**

When removing refrigerant from a system, either for servicing or decommissioning, it is recommended good practice that all refrigerants are removed safely. When transferring refrigerant into cylinders, ensure that only appropriate refrigerant recovery cylinders are employed. Ensure that the correct number of cylinders for holding the total system charge are available. All cylinders to be used are designated for the recovered refrigerant and labelled for that refrigerant (i.e. special cylinders for the recovery of refrigerant). Cylinders shall be complete with pressure-relief valve and associated shut-off valves in good working order. Empty recovery cylinders are evacuated and, if possible, cooled before recovery occurs. The recovery equipment shall be in good working order with a set of instructions concerning the equipment that is at hand and shall be suitable for the recovery of all appropriate refrigerants including, when applicable, flammable refrigerants. In addition, a set of calibrated weighing scales shall be available and in good working order. Hoses shall be complete with leak-free disconnect couplings and in good condition. Before using the recovery machine, check that it is in satisfactory working order, has been properly maintained and that any associated electrical components are sealed to prevent ignition in the event of a refrigerant release. Consult manufacturer if in doubt.

The recovered refrigerant shall be returned to the refrigerant supplier in the correct recovery cylinder, and the relevant waste transfer note arranged. Do not mix refrigerants in recovery units and especially not in cylinders. If compressors or compressor oils are to be removed, ensure that they have been evacuated to an acceptable level to make certain that flammable refrigerant does not remain within the lubricant. The evacuation process shall be carried out prior to returning the compressor to the suppliers. Only electric heating to the compressor body shall be employed to accelerate this process. When oil is drained from a system, it shall be carried out safely.



Αποκομιδή Παλαιού Ηλεκτρικού & Ηλεκτρονικού Εξοπλισμού (Ισχύει στην Ευρωπαϊκή Ένωση και άλλες Ευρωπαϊκές χώρες με συστήματα επιλεκτικής συλλογής απορριμμάτων). Το σύμβολο αυτό επάνω στο προϊόν ή στη συσκευασία του σημαίνει ότι το προ-

ϊόν δεν πρέπει να πεταχτεί μαζί με τα οικιακά απορρίμματα αλλά πρέπει να παραδοθεί σε ένα κατάλληλο σημείο συλλογής ηλεκτρι-

κού και ηλεκτρονικού υλικού προς ανακύκλωση. Εξασφαλίζοντας τη σωστή αποκομιδή του προϊόντος βοηθάτε στην πρόληψη πιθανών αρνητικών επιπτώσεων στο περιβάλλον και την υγεία. Η ανακύκλωση των υλικών θα βοηθήσει στην εξοικονόμηση φυσικών πόρων. Για περισσότερες πληροφορίες σχετικά με την ανακύκλωση αυτού του προϊόντος, παρακαλούμε επικοινωνήστε με τις υπηρεσίες καθαριότητας του δήμου σας ή το κατάστημα όπου αγοράσατε το προϊόν



This marking indicates that this product should not be disposed with other household wastes throughout the EU. To prevent possible

harm to the environment or human health from uncontrolled waste disposal, please recycle it responsibly to promote the sustainable reuse of material resources. By ensuring proper product disposal, you help prevent potential negative environmental and health impacts. Recycling

materials will help save natural resources. To dispose/return your used device please follow the return and collection systems of your country or contact the retailer from where you purchased this product. This product must be send for environmental safe recycling.



Questo marchio indica che questo prodotto non deve essere smaltito con altri rifiuti domestici in tutta l'UE. Per prevenire possibili

danni all'ambiente o alla salute umana causati dallo smaltimento incontrollato dei rifiuti, riciclarli in modo responsabile per promuovere il riutilizzo sostenibile delle risorse materiali. Garantendo il corretto smaltimento del prodotto, si aiuta a prevenire potenziali impatti negativi

sull'ambiente e sulla salute. Il riciclaggio dei materiali aiuterà a salvare le risorse naturali. Per smaltire / restituire il dispositivo usato, segui i sistemi di restituzione e raccolta del tuo paese o contatta il rivenditore da cui hai acquistato questo prodotto. Questo prodotto deve essere inviato per il riciclaggio sicuro per l'ambiente.

Δήλωση συμμόρφωσης CE

Ο Εισαγωγέας Γ.Ε.ΔΗΜΗΤΡΙΟΥ Α.Ε.Ε. δηλώνει πως αυτό το προϊόν πληροί τις γενικές απαιτήσεις των παρακάτω ευρωπαϊκών οδηγιών:

LVD: 2014/35/EU

EMC: 2014/30/EU

RoHS: (EU)2015/863

ERP: 2011/65/EU

RED: 2014/53/EU

WiFi: Μέγιστη Εκπεμπόμενη Ισχύς: 18dBm

Εύρος Συχνότητας Λειτουργίας: 2412MHz - 2472MHz

Ως εκ τούτου, το προϊόν έχει σήμανση με το σύμβολο **CE** και η **Δήλωση Συμμόρφωσης** έχει χορηγηθεί στον κατασκευαστή και είναι στη διάθεση των αρμοδίων αρχών εποπτείας της αγοράς.

Certificate of compliance CE

TOYOTOMI CO., LTD declares that this product complies with the general requirements pursuant to the following European Directives:

LVD: 2014/35/EU

EMC: 2014/30/EU

RoHS: (EU)2015/863

ERP: 2011/65/EU

RED: 2014/53/EU

WiFi: Wireless maximum transmit power: 18dBm

Wireless frequency range: 2412MHz - 2472MHz

Therefore the product has been marked with the **CE** symbol and the **Declaration of Conformity** has been issued and is available to the competent authorities regulating the market.

Certificato di Conformità CE

TOYOTOMI ITALIA S.R.L. dichiara che questo prodotto è conforme ai requisiti generali secondo le seguenti Direttive Europee:

LVD: 2014/35/EU

EMC: 2014/30/EU

RoHS: (EU)2015/863

ERP: 2011/65/EU

RED: 2014/53/EU

WiFi: Potenza di trasmissione massima: 18dBm

Gamma di frequenza: 2412MHz - 2472MHz

Pertanto il prodotto è stato contrassegnato con il simbolo **CE** ed è stata rilasciata la **Dichiarazione di Conformità** che è a disposizione delle autorità competenti che regolano il mercato.

Απαγορεύεται η ανατύπωση ή αναπαραγωγή ολόκληρου ή μέρους αυτού του εγχειριδίου με οποιοδήποτε τρόπο, χωρίς την έγγραφη άδεια της Γ.Ε.ΔΗΜΗΤΡΙΟΥ Α.Ε.Ε.

It is prohibited to reprint or reproduction of all or part of this manual in any manner without written permission of TOYOTOMI CO., LTD

È vietato ristampare o riprodurre tutto o parte di questo manuale in qualsiasi modo senza il permesso scritto di TOYOTOMI ITALIA S.R.L.

ΕΠΙΣΗΜΗ ΑΝΤΙΠΡΟΣΩΠΕΙΑ ΕΛΛΑΔΑΣ

Γ.Ε.ΔΗΜΗΤΡΙΟΥ Α.Ε.Ε.

ΛΕΩΦ. ΚΗΦΙΣΟΥ 6, ΑΙΓΑΛΕΩ, ΑΘΗΝΑ

Τηλ.: +30 210 5386400

Fax: +30 210 5913664

<http://www.toyotomi.gr>

SERVICE / ΑΝΤΑΛΛΑΚΤΙΚΑ

Γ.Ε.ΔΗΜΗΤΡΙΟΥ Α.Ε.Ε.

ΛΕΩΦ. ΚΗΦΙΣΟΥ 6, ΑΙΓΑΛΕΩ, ΑΘΗΝΑ

Τηλ.: +30 210 5386490

Fax: +30 210 5313349

OFFICIAL REPRESENTATIVE ITALY

TOYOTOMI ITALIA S.R.L.

VIA T. EDISON, 11

20875 BURAGO DI MOLGORA (MB)

Tel: +39 039 6080392

Fax: +39 039 6080316

<http://www.toyotomi.it>

OFFICIAL REPRESENTATIVE NETHERLANDS

TOYOTOMI EUROPE SALES B.V.

HUYGENSWEG 10, 5466 AN VEGHEL

Tel: +31 (0)413 82 02 95

Fax: +31 (0)413 74 50 38

<http://www.toyotomi.eu>

REPRESENTANTE OFICIAL ESPANA

TOYOTOMI EUROPE SALES SPAIN S.A.

CALLE TRIGO, 9 BAJO 2, 28914 LEGANÉS (MADRID)

Tel: +34 91 6895583

Fax: +34 91 6895584

<http://www.toyotomi.es>

Το προϊόν κατασκευάζεται στην Κίνα

This product is made in China

Questo prodotto è fabbricato in Cina

Este producto ha sido fabricado en China

